

Keysight Technologies

34450A Multimeter

5.5 Digit Dual Display, Benchtop DMM

Data Sheet



Features

- Fast reading speed of up to 190 readings/sec
- 0.015% DCV accuracy
- Multiple connectivity options – USB 2.0, Serial Interface (RS-232) and GPIB
- 11 measurement functions; DC voltage & current, True RMS AC voltage & current, 2- and 4-wire resistance, frequency, continuity, diode test, capacitance and temperature
- Ultra-bright OLED with dual display capability
- Up to 50,000 memory points for data logging
- Built-in Histogram function
- With Fluke 45 and Fluke 8808A code compatibility

Achieve throughput breakthrough

Turbo charge your production line with the 34450A digital multimeter. With its fast speed of up to 190 readings per second you can now increase your manufacturing throughput tremendously. Get highly accurate, repeatable and trustworthy measurements with the 0.015% DCV accuracy designed to meet general industrial and educational needs.

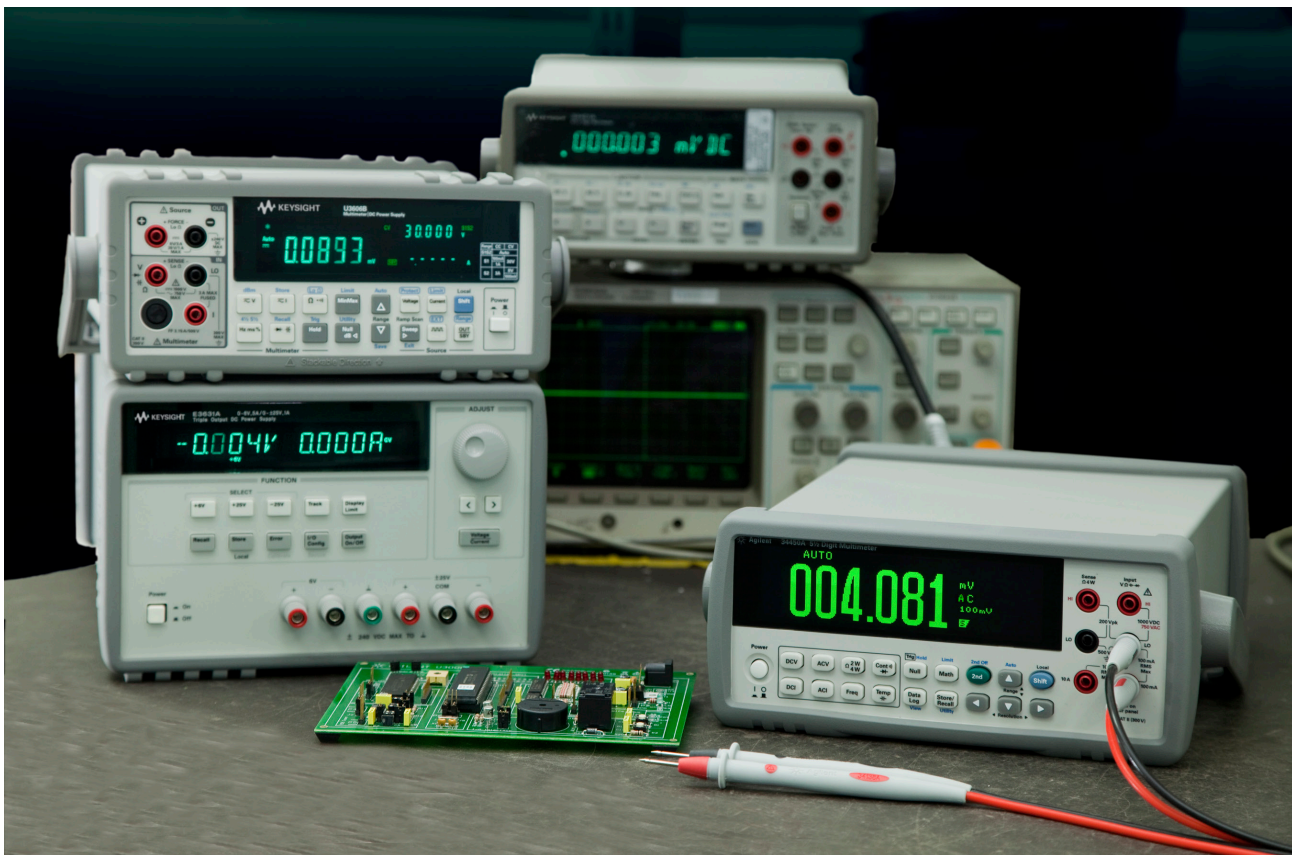

Figure 1. Bright OLED display for excellent viewing experience when making measurements.

Intuitive and multipurpose device

The 34450A is an intuitive and easy to use tool that provides a wide range of measurement functions such as DC voltage, DC current, True RMS AC voltage and AC current, 2-wire and 4-wire resistance, frequency, diode test, continuity, capacitance and temperature. Simplify your day-to-day task with up to 50,000 memory points, allowing you to capture and log up to 14 hours of data. Built-in with histogram and basic statistical functions, you can now do simple data analysis within the unit itself. With its ultra-bright OLED dual display, different measurements can be performed ensuring you get the right readings at first glance.

More flexibility with multiple connectivity

Multiple connectivity options such as USB 2.0, Serial Interface (RS-232) and GPIB port provides greater flexibility to connect DMM to a PC for data access and retrieval for analysis. With the option to connect to a PC, this enables the 34450A to work with Keysight Connectivity software and can be controlled remotely via SCPI commands or Command Expert. The IVI-COM driver is also included to ensure an easy integration with different programming environments.

Easy migration

Upgrading your obsoleted DMM is made easy with minimal changes to test program. To ensure both forward and backward compatibility, the 34450A includes SCPI, Fluke 45 or Fluke 8808A commands. Experience a quick, easy and painless migration as it allows you to quickly transfer your existing test programs on the Keysight 34450A.

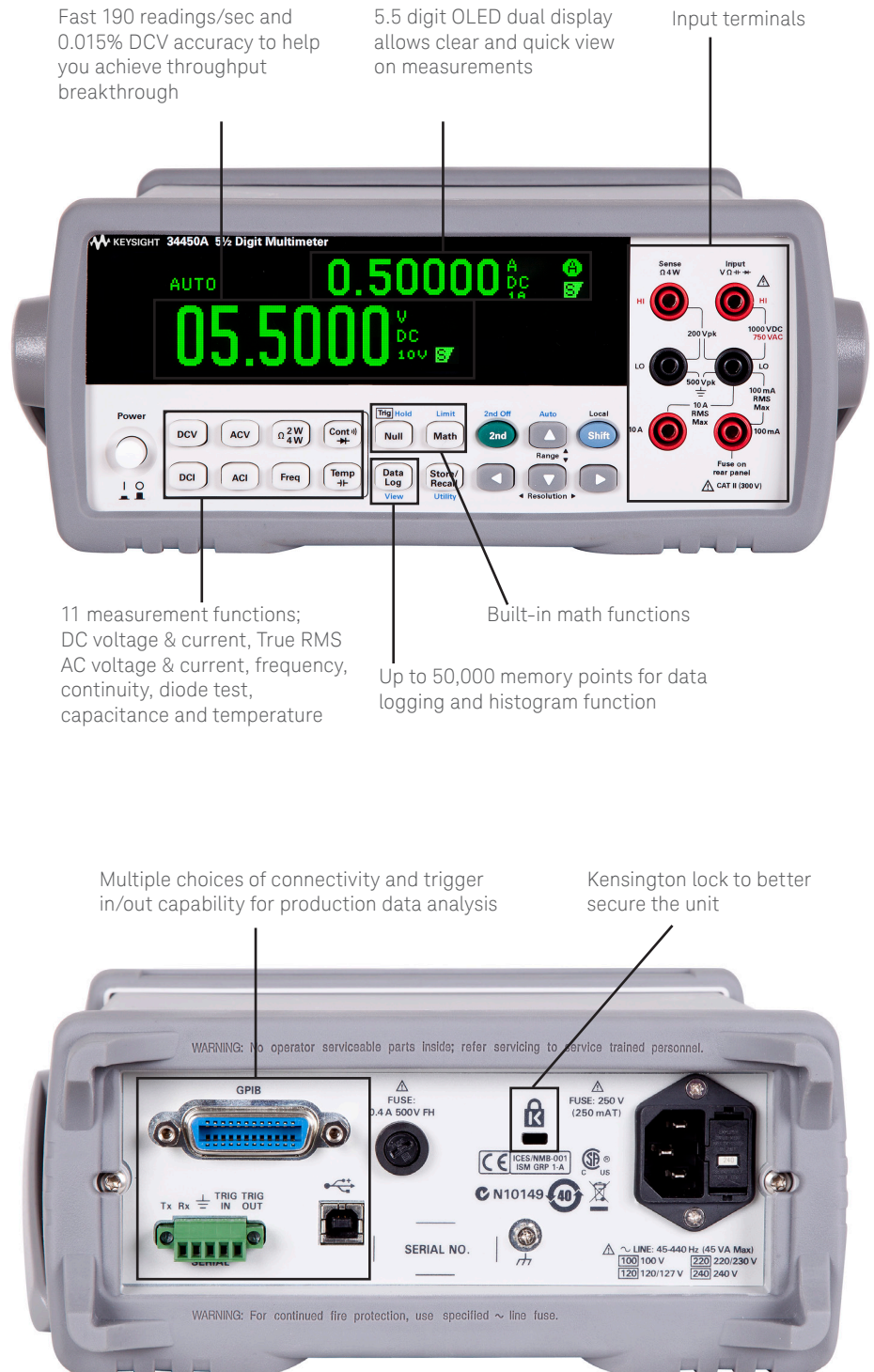

Specifications

DC specification

Specifications are for 90 minutes warm-up time, slow mode, and calibration temperature within 18 °C - 28 °C

Table 1. DC accuracy ± (% of reading + % of range)

Function	Range ¹	Test current or burden voltage	Input impedance	1 year 23 °C ± 5 °C	Temperature coefficient 0 °C - 18 °C 28 °C - 55 °C
DC voltage	100.000 mV	–	10 MΩ or > 10 GΩ	0.018 + 0.008	0.0020 + 0.0008
	1.00000 V	–	10 MΩ or > 10 GΩ	0.015 + 0.005	0.0015 + 0.0008
	10.0000 V	–	10 MΩ	0.015 + 0.005	0.0020 + 0.0008
	100.000 V	–	10 MΩ	0.015 + 0.005	0.0020 + 0.0008
	1000.00 V	–	10 MΩ	0.015 + 0.005	0.0020 + 0.0008
Resistance (2-wire) ²	100.000 Ω	1 mA	–	0.050 + 0.008	0.0060 + 0.0008
	1.00000 kΩ	500 μA	–	0.050 + 0.008	0.0060 + 0.0005
Resistance (4-wire) ²	10.0000 kΩ	100 μA	–	0.050 + 0.005	0.0060 + 0.0005
	100.000 kΩ	10 μA	–	0.050 + 0.005	0.0060 + 0.0005
	1.00000 MΩ	1 μA	–	0.060 + 0.005	0.0060 + 0.0005
	10.0000 MΩ	100 nA	–	0.250 + 0.005	0.0250 + 0.0005
	100.000 MΩ	100 nA/10 MΩ	–	2.000 + 0.005	0.3000 + 0.0005
DC current	100.000 μA	< 0.02 V	–	0.05 + 0.015	0.007 + 0.0015
	1.00000 mA	< 0.2 V	–	0.05 + 0.007	0.007 + 0.0010
	10.0000 mA	< 0.02 V	–	0.05 + 0.015	0.008 + 0.0015
	100.000 mA	< 0.2 V	–	0.05 + 0.007	0.008 + 0.0010
	1.00000 A	< 0.2 V	–	0.10 + 0.015	0.012 + 0.0015
	10.0000 A	< 0.6 V	–	0.25 + 0.007	0.015 + 0.0010
Continuity ³	1000 Ω	0.5 mA	–	0.05 + 0.03	0.005 + 0.005
Diode test ⁴	1.0000 V	0.5 mA	–	0.05 + 0.03	0.005 + 0.005

Notes on specifications:

- 20% over range on all ranges except 1000 VDC and 10 A range.
- Specifications are for 4-wire Ω or 2-wire Ω using NULL function. If without NULL function, add 0.2 Ω additional error.
- Continuity thresholds is fixed at less than 10 Ω
- Specifications are for the voltage measured at the input terminals only.

AC specifications

Specifications are for 90 minutes warm-up time, slow mode, and calibration temperature within 18 °C - 28 °C

Table 2. AC Accuracy ± (% of reading + % of range)

Function	Range ¹	Frequency	1 year 23 °C ± 5 °C	Temperature coefficient 0 °C - 18 °C 28 °C - 55 °C
True RMS AC voltage ²	100.000 mV	20 Hz – 45 Hz	1.0 + 0.1	0.02 + 0.02
		45 Hz – 10 kHz	0.2 + 0.1	0.02 + 0.02
		10 kHz – 30 kHz	1.5 + 0.3	0.05 + 0.02
		30 kHz – 100 kHz ³	3.0 + 0.3	0.10 + 0.02
	1.00000 V to 750.00 V	20 Hz – 45 Hz	1.0 + 0.1 ⁴	0.02 + 0.02
		45 Hz – 10 kHz	0.2 + 0.1	0.02 + 0.02
		10 kHz – 30 kHz	1.5 + 0.3	0.05 + 0.02
		30 kHz – 100 kHz ³	3.0 + 0.3 ⁵	0.10 + 0.02
True RMS AC current ²	10.0000 mA to 10.0000 A	20 Hz – 45 Hz	1.5 + 0.1	0.02 + 0.02
		45 Hz – 1 kHz	0.5 + 0.1	0.02 + 0.02
		1 kHz – 10 kHz ⁶	2.0 + 0.2	0.02 + 0.02

Notes on specifications:

- 20% over range on all ranges except ACV 750 V and ACI 10 A
- Specifications are for sine-wave inputs more than the 5% of range except 750 V range. Input signal must be more than 50 Vrms for 750 V range. Maximum crest factor of 3 at full scale. Input impedance is 1 MΩ in parallel with capacitance less than 120 pF, AC couple with up to 400 DCV
- Additional error to be added as frequency > 30 kHz and signal input < 10% of range. 30 kHz to 100 kHz: 0.003% of full scale per kHz
- For input < 200 V rms
- For input < 300 V rms
- Frequencies > 5 kHz are typical for all ranges

Table 3. Frequency Accuracy ± (% of reading + 3 counts)

Function	Range ¹	Frequency	1 year 23 °C ± 5 °C	Temperature coefficient 0 °C - 18 °C 28 °C - 55 °C
Frequency	100.000 mV to 750.00 V ¹	20 Hz – 300 kHz ²	0.02 + 3	0.005
	10.0000 mA to 10.0000 A	20 Hz – 10 kHz ³	0.02 + 3	0.005

Notes on specifications:

- The frequency can be measured up to 1 MHz as 0.5 V signal to 100 mV/1 V ranges.
- 10% of range to full scale input on all ranges except where noted. 100 mV range specifications are for full scale or greater inputs. For inputs from 10 mV to 100 mV, multiply total % of reading error by 10.
- 10% of range to full scale input on all ranges except where noted. 10 mA range specifications are for full scale or greater inputs. For inputs from 1 mA to 10 mA, multiply total % of reading error by 10.

Table 4. Frequency resolution

Function	Range	Frequency	Resolution
Frequency	100.000 mV to 750.00 V ¹	119.999 Hz	0.001 Hz
		1.19999 kHz	0.00001 kHz
		11.9999 kHz	0.0001 kHz
		119.999 kHz	0.001 kHz
		1.19999 MHz	0.00001 MHz

- The frequency can be measured up to 1 MHz as 0.5 V signal to 100 mV/1 V ranges.

Temperature and capacitance specifications

Specifications are for 90 minutes warm-up time, slow mode, and calibration temperature within 18 °C - 28 °C

Table 5. Temperature and capacitance accuracy ± (% of reading + % of range)

Function	Range ¹	Probe type or test current	1 year 23 °C ± 5 °C	Temperature coefficient 0 °C - 18 °C 28 °C - 55 °C
Temperature	- 80.0 °C to 150 °C	5 kΩ thermistor probe	Probe accuracy + 0.2 °C	0.002 °C
	- 110.0 °F to 300.0 °F	5 kΩ thermistor probe	Probe accuracy + 0.4 °F	0.0036 °F
Capacitance	1.000 nF	100 nA	–	–
	10.00 nF	100 nA	1 + 0.5	0.02 + 0.001
	100.0 nF	1.0 μA	1 + 0.5	0.02 + 0.001
	1.0000 μF	1.0 μA	1 + 0.5	0.02 + 0.001
	10.000 μF	10 μA	1 + 0.5	0.02 + 0.001
	100.00 μF	100 μA	1 + 0.5	0.02 + 0.001
	1000.0 μF	0.5 mA	1 + 0.5	0.02 + 0.001
	10,000 μF	1.0 mA	2 + 0.5	0.02 + 0.001

Notes on specifications:

1. 20% over range on all ranges.

Operating specifications

Table 6. Operating specifications on single display (approximate)

Function	Resolution	Function change (sec) ¹	Range change (sec) ²	Auto range (sec) ³	Reading rate/sec ⁴		
					USB	GPIB	Serial
ACV	Slow (5.5)	2.6	2.5	4.6	1.9	1.9	1.9
	Med (4.5)	1.2	1.2	1.5	19	19	19
	Fast (4.5)	1.1	1.1	1.2	160	99	33
DCV	Slow (5.5)	1.3	1.3	1.6	1.7	1.7	1.7
	Med (4.5)	0.6	0.7	0.8	49	49	24
	Fast (4.5)	0.6	0.7	0.7	190	117	34
2-wire Ω	Slow (5.5)	1.2	1.3	1.6	1.4	1.4	1.4
	Med (4.5)	0.4	0.5	0.6	49	49	24
	Fast (4.5)	0.4	0.5	0.5	165	110	32
4-wire Ω	Slow (5.5)	1.2	1.4	1.9	1	1	1
	Med (4.5)	0.6	0.6	1.1	5.2	5.3	4.7
	Fast (4.5)	0.6	0.6	1	5.9	5.9	5.3
Frequency ⁵	Slow (5.5)	2.1	2.1	2.6	0.9	0.9	0.9
	Med (4.5)	1.2	1.2	1.7	0.9	0.9	0.9
	Fast (4.5)	–	–	–	–	–	–
ACI	Slow (5.5)	2.6	2.6	6.2	1.9	1.9	1.9
	Med (4.5)	1.2	1.2	1.7	19	19	33
	Fast (4.5)	1.1	1.2	1.3	160	99	33
DCI	Slow (5.5)	1.3	1.3	1.9	1.7	1.7	1.7
	Med (4.5)	0.6	0.7	0.9	49	49	24
	Fast (4.5)	0.6	0.7	0.7	190	116	36
Diode	4.5	0.1	–	–	190	117	38
Continuity	4.5	0.1	–	–	165	111	33
Temperature	4.5	0.5	–	–	4.2	4.2	3

Notes on specifications:

1. Time to change from 2-wire resistance to this specified function and to take at least one reading using SCPI "FUNC" and "READ?" commands.
2. Time to change from one range to the next higher range and to take at least one reading using SCPI "FUNC" and "READ?" commands.
3. Time to automatically change one range and to take at least one reading using SCPI "CONF AUTO" and "READ?" commands.
4. Number of measurements using SCPI "READ?" command when front panel display is off using "DISP OFF" command.
5. Reading rate depends on signal frequency \geq 20 Hz.

Supplemental measurement specifications

Table 7. Supplemental measurement specifications

Specification measurement		Specification
DC voltage	Measuring method:	Sigma delta A-to-D converter
	Input resistance:	> 10 G Ω \pm 2% range (Selectable 100 mV, 1 V ranges) 10 M Ω \pm 2% range (typical)
	Input protection:	1000 V on all ranges (HI terminal)
Resistance	Measurement method:	2-wire or 4-wire Ohms
	Open circuit voltage:	Limited to < 2.8 V
	Input protection:	1000 V on all ranges (HI terminal)
DC current	Shunt resistance:	1 Ω for 10 mA, 100 mA 90 Ω for 100 μ A, 1 mA 0.01 Ω for 1 A, 10 A
	Input protection:	Externally accessible at rear panel 0.4 A, 500 V fuse for I terminal Internal 11 A, 1000 V fuse for 10 A terminal
Continuity/diode test	Measurement method:	Uses 0.5 mA \pm 0.2% constant current source
	Response time:	– Continuity: 165 samples/second with audible tone – Diode: 190 samples/second with audible tone
	Continuity threshold:	10 Ω fixed
	Input protection:	1000 V (HI terminal)
Temperature	Measurement method:	2-wire Ohms measurement of 5 k Ω thermistor sensor (YSI 4407) with computer conversion Auto-ranging measurement, no manual range selection
	Input Protection:	1000 V (HI terminal)
Measurement noise rejection	CMR (Common mode rejection) For 1 k Ω unbalance LO lead	DC 140 dB AC 70 dB
	NMR (Normal mode rejection) For 60 Hz (50 Hz) \pm 0.1%	Slow mode 5½ digits 90 dB Medium mode 4½ digits 55 dB Fast mode 4½ digits 0 dB
AC voltage	Measurement method:	AC coupled true-rms – measures the AC component with up to 400 VDC bias any range
	Crest factor:	Maximum 3:1 at full scale
	Input impedance:	1 M Ω \pm 2% in parallel with < 100 pF of all ranges
	Input protection:	750 V rms on all ranges (HI terminal)
AC current	Measurement method:	DC coupled to the fuse and current shunt, AC coupled true rms measurement (measures the AC component only)
	Shunt resistance:	1 Ω for 10 mA, 100 mA 0.01 Ω for 1 A, 10 A
	Input protection:	Externally accessible at rear panel 0.4 A, 500 V fuse for I terminal Internal 11 A, 1000 V fuse for 10 A terminal

Table 7. Supplemental measurement specifications (continued)

Specification measurement	Specification	
Frequency	Measurement method:	Reciprocal counting technique. AC coupled input using AC voltage function.
	Signal level:	10% of range to full scale input on all ranges except where noted. Auto or manual range selection
	Gate time:	0.1 second or 1 period of the input signal.
	Input protection:	750 V rms on all ranges (HI terminal)
Math functions	Null, dBm, dB, Min/Max/Avg, hold, limit test	
Data log	Info, list, histogram	
Triggering and memory	Samples per trigger:	1 to 5,000 (typical), 1 to 50,000 (optional)
	Trigger delay:	0 to 3600 sec (100 us step size)
Trigger out	3.3 V logic output	
	Polarity:	Negative pulse
	Pulse width:	Approximately 3 μ s
Non-volatile memory	50,000 readings	
Sample timer	Range:	Up to 3600 sec in 100 μ s steps
Remote interface	USB 2.0 Standard, GPIB IEEE-488 (Optional)	
Programming language	SCPI-1994.0, IEEE-488.2	

General characteristics

Table 8. General Characteristics

Specification measurement	Specification
Power supply	<ul style="list-style-type: none"> – 100 V/120 V(127 V)/220 V(230 V)/240 V \pm 10% – AC line frequency 45 Hz - 66 Hz and (360 Hz - 440 Hz, 100/120 V operation) – Automatically sensed at power -on
Power consumption	45 VA maximum, < 11 W average
Operating environment	Full accuracy at 0° C to 55° C Full accuracy to 80% RH at 30° C (non-condensing) Altitude up to 3000 meters
Storage compliance	-40 °C to 70 °C
Safety compliance	<ul style="list-style-type: none"> – IEC 61010-1:2001/EN 61010-1:2001 (2nd Edition) – Canada: CAN/CSA-C22.2 No. 61010 -1 -04 – USA: ANSI/UL std No. 61010-1:2004
Measurement category	CAT II, 300 V: CAT I 1000 Vdc, 750 Vac rms, 2500 Vpk transient over voltages, Pollution degree 2
EMC compliance	Certified to IEC61326-1: 2005/EN61326-1:2006 CISPR 11:2003 / EN 55011:2007 Group 1 Class A Canada: ICES/NMB-001:Issue 4, June 2006 Australia/New Zealand: AS/NZS CISPR 11:2004
Shock and vibration	Tested to IEC/EN 60086-2
Dimension (HxWxD)	Rack: 88.5 mm x 212.6 mm x 272.3 mm Bench: 103.8 mm x 261.1 mm x 303.2 mm
Weight	3.75 kg (8.27 lb.)
Warm up time	90 minutes

Dimensions

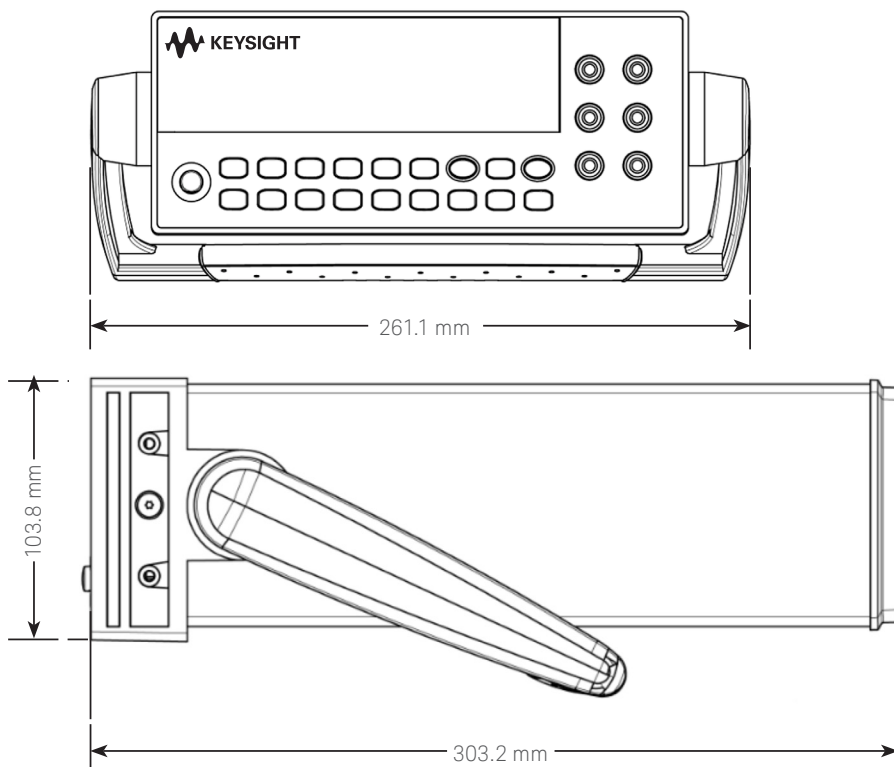

Standard shipped accessories

- Test lead set
- Power cord
- USB interface cable
- Quick Start Guide
- Product Reference CD
- Keysight IO Library Suite CD-ROM

Upgradable options

- 3445GPBU - GPIB connectivity upgrade
- 3445MEMU - 50,000 memory points upgrade for data logging

Keysight optional accessories:



34138A test lead set

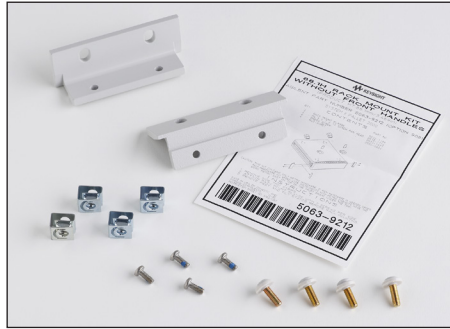

34191A 2U dual flange kit:
secures the instrument to the front of the rack. This kit can be used with the 34194A dual lock link kit to mount two half-width, 2U height instruments side-by-side.



82350B PCI high-performance GPIB interface card



E2308A thermistor temperature probe

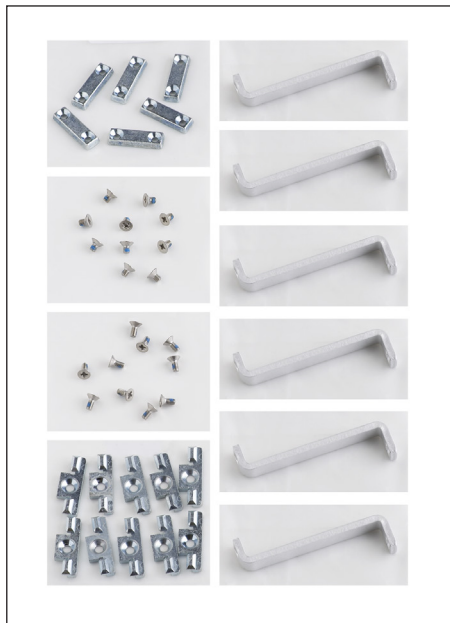

34194A dual lock link kit:
recommended for side-by-side combinations and includes links for instruments of different depths. This kit can be used with the 34191A 2U dual flange kit to mount two half-width, 2U height instruments side-by-side.

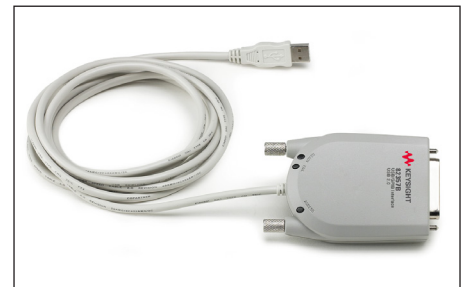

82357B USB/GPIB interface high-speed USB 2.0



10833A/B/C/D/F/G GPIB cable in various lengths (0.5 m, 1 m, 2 m, 4 m, 0.5 m, 6 m and 8 m)

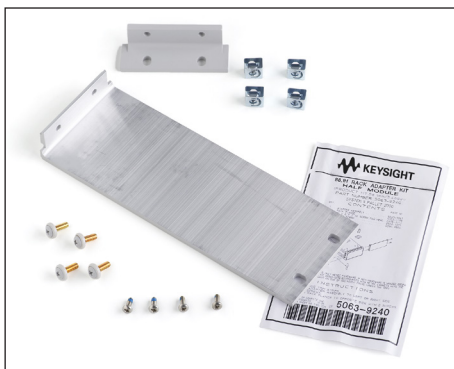

34190A rackmount kit:
designed for use with only one instrument, mounted on either the left or the right side of the rack.

Evolving Since 1939

Our unique combination of hardware, software, services, and people can help you reach your next breakthrough. We are unlocking the future of technology.

From Hewlett-Packard to Agilent to Keysight.

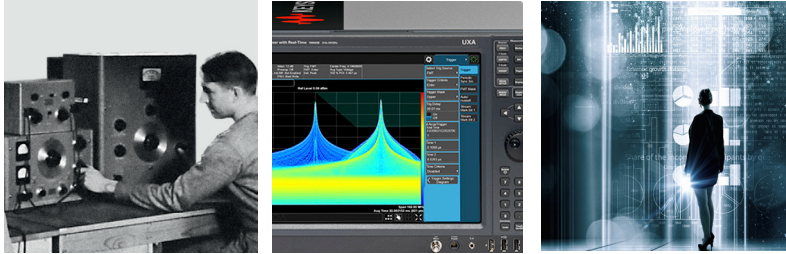

For more information on Keysight Technologies' products, applications or services, please contact your local Keysight office. The complete list is available at: www.keysight.com/find/contactus

Americas

Canada	(877) 894 4414
Brazil	55 11 3351 7010
Mexico	001 800 254 2440
United States	(800) 829 4444

Asia Pacific

Australia	1 800 629 485
China	800 810 0189
Hong Kong	800 938 693
India	1 800 11 2626
Japan	0120 (421) 345
Korea	080 769 0800
Malaysia	1 800 888 848
Singapore	1 800 375 8100
Taiwan	0800 047 866
Other AP Countries	(65) 6375 8100

Europe & Middle East

Austria	0800 001122
Belgium	0800 58580
Finland	0800 523252
France	0805 980333
Germany	0800 6270999
Ireland	1800 832700
Israel	1 809 343051
Italy	800 599100
Luxembourg	+32 800 58580
Netherlands	0800 0233200
Russia	8800 5009286
Spain	800 000154
Sweden	0200 882255
Switzerland	0800 805353
	Opt. 1 (DE)
	Opt. 2 (FR)
	Opt. 3 (IT)
United Kingdom	0800 0260637

For other unlisted countries: www.keysight.com/find/contactus (BP-9-7-17)

DEKRA Certified
ISO 9001 Quality Management System

www.keysight.com/go/quality
Keysight Technologies, Inc.
DEKRA Certified ISO 9001:2015
Quality Management System

myKeysight

myKeysight

www.keysight.com/find/mykeysight

A personalized view into the information most relevant to you.

www.keysight.com/find/emt_product_registration

Register your products to get up-to-date product information and find warranty information.

KEYSIGHT SERVICES

Accelerate Technology Adoption.
Lower costs.

Keysight Services

www.keysight.com/find/service

Keysight Services can help from acquisition to renewal across your instrument's lifecycle. Our comprehensive service offerings—one-stop calibration, repair, asset management, technology refresh, consulting, training and more—helps you improve product quality and lower costs.



Keysight Assurance Plans

www.keysight.com/find/AssurancePlans

Up to ten years of protection and no budgetary surprises to ensure your instruments are operating to specification, so you can rely on accurate measurements.

Keysight Channel Partners

www.keysight.com/find/channelpartners

Get the best of both worlds: Keysight's measurement expertise and product breadth, combined with channel partner convenience.

www.keysight.com/find/34450A



This information is subject to change without notice.
© Keysight Technologies, 2014 - 2017
Published in the USA November 18, 2017
5991-1133EN
www.keysight.com