

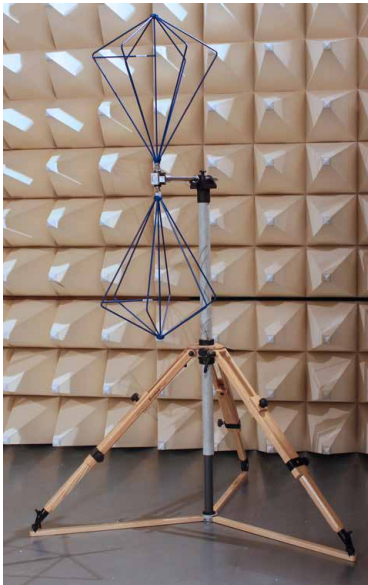

VBA 6106A BICONICAL ANTENNA 30 MHz TO 300 MHz



VBA 6106A vertical onto tripod
BTP 6020A

- Ideal for compliance emission testing
- Conventional VHF broadband test antenna
- Lightweight and compact
- Excellent balance
- Low measurement uncertainty

The lightweight antenna VBA 6106A offers a compact solution to measurements in the frequency range 30 to 300 MHz. It is ideal for open site measurements or applications in anechoic chambers where space is at a premium. The VBA 6106A has a coaxial wound balun and can be used to transmit signals. The maximum continuous input power is 10 Watts.

Above approximately 70 MHz the antenna factor is similar to that of a tuned half wave dipole but allows measurements to be made without the need to adjust the antenna at each frequency. Below 70 MHz the antenna factor is higher than that of a tuned half wave dipole but is adequate for many purposes and is much smaller.

At frequencies near 30 MHz, the adjustable half wave dipole elements 'droop', and may overhang the ground plane of an open air test site, when horizontally polarized.

Both these effects can cause significant errors and measurement repeatability problems. The smaller, rigid construction of the VBA 6106A overcomes these problems. Biconical antennas are preferred in the range 30 MHz to 250 MHz by CISPR 16-1-4 in order to achieve a low measurement uncertainty.

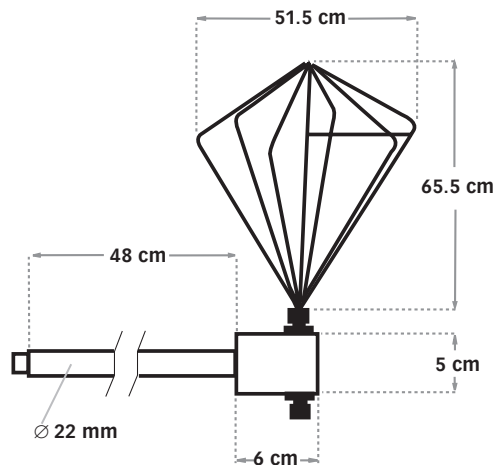

Technical specifications

Frequency range:	30 MHz to 300 MHz
Impedance (nominal):	50 Ω
Maximum continuous power:	10 W
Connector:	N type female
Size antenna (L x H x W in mm):	approx. 1360 X 770 X 515 (see drawing)
Weight:	approx. 1.3 kg
Size of cardboard box:	73 cm x 61 cm x 61 cm
Shipping weight:	approx. 6 kg
Recommended tripod:	BTP 6020A

VBA 6106A BICONICAL ANTENNA 30 MHz TO 300 MHz

Typical antenna factor

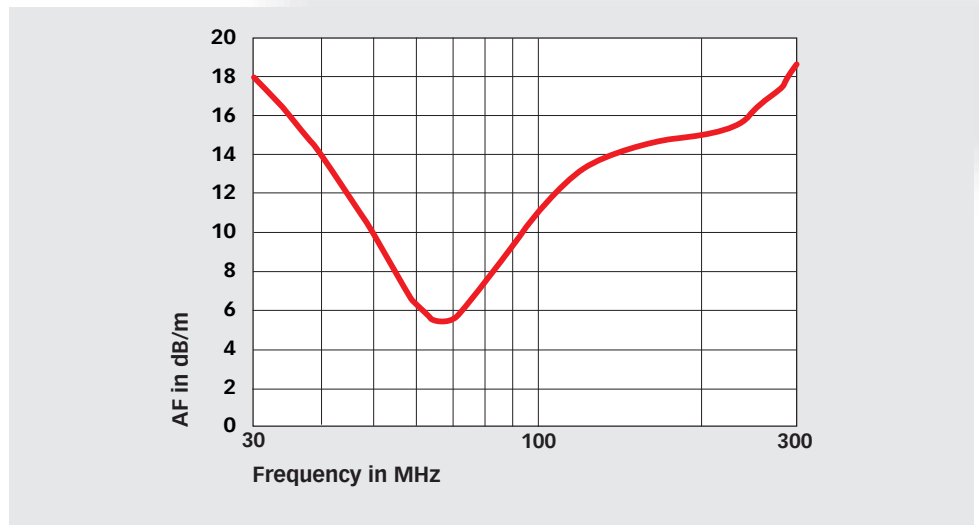

Typical VSWR

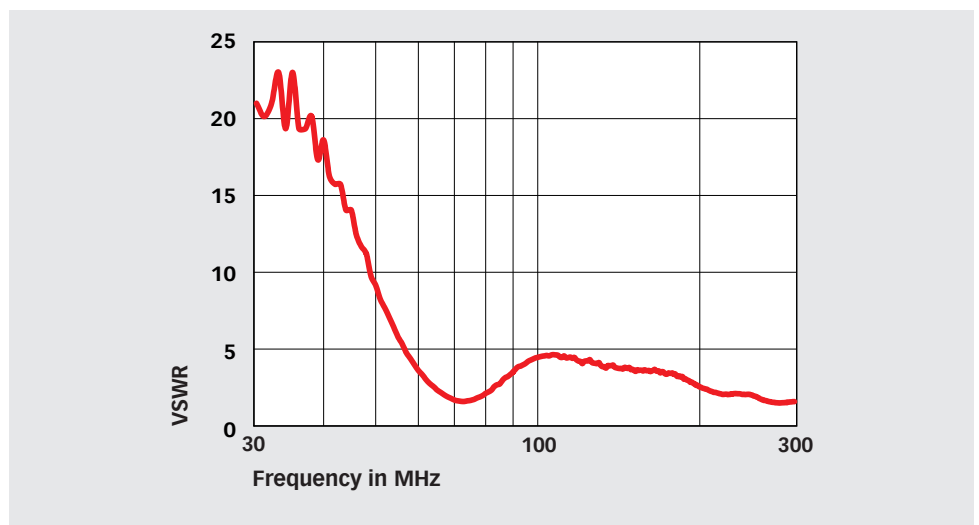



VBA 6106A BICONICAL ANTENNA 30 MHz TO 300 MHz



Typical gain ratio

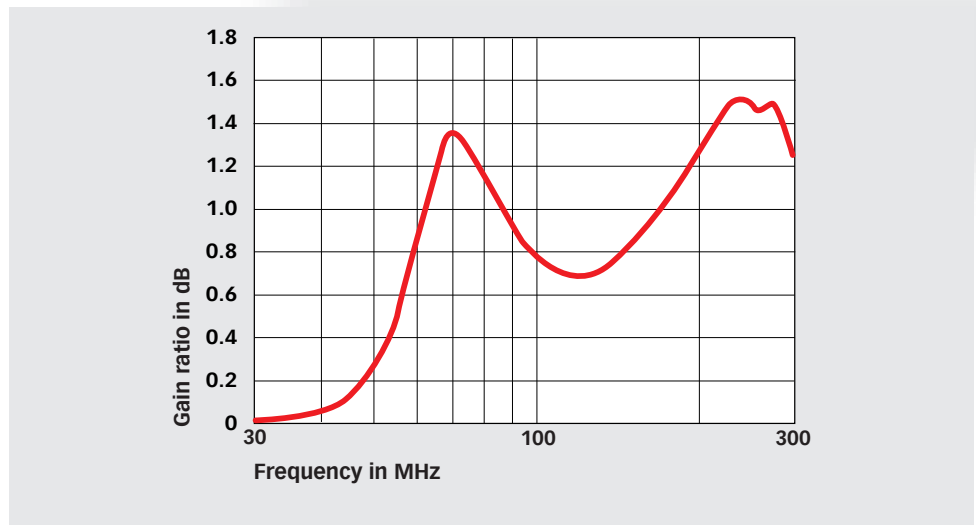

Typical gain

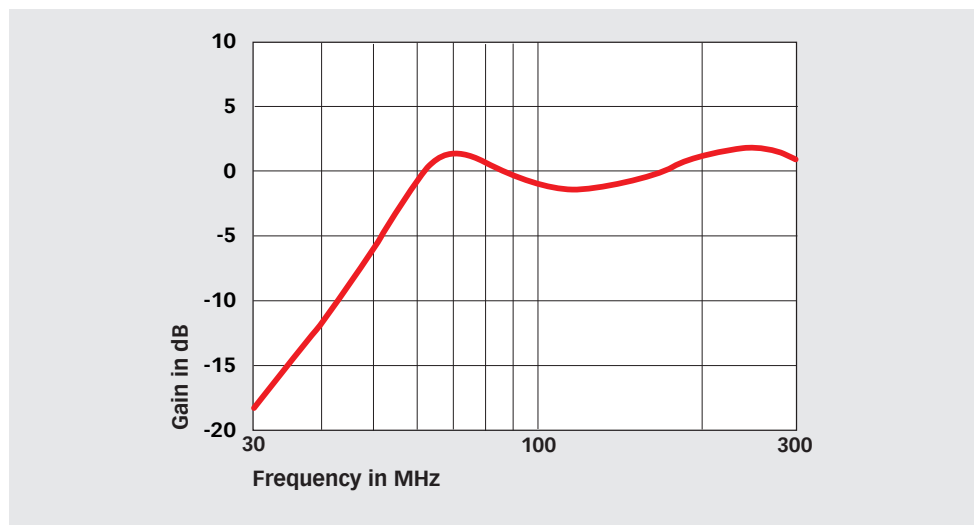



VBA 6106A BICONICAL ANTENNA 30 MHz TO 300 MHz

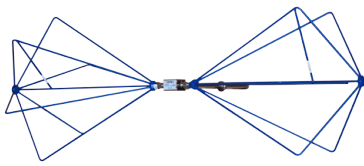

VBA 6106A

Typical balance

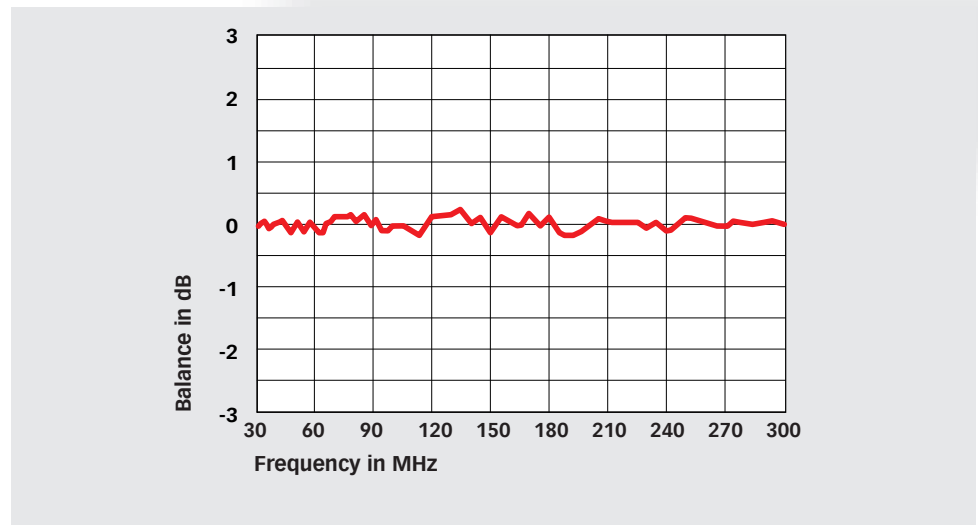

Delivery information

Part number	Description
346-740	VBA 6106A VHF Biconical antenna 30 MHz - 300 MHz
97-244570	Ant Cert-TC Traceable calibration (ISO17025), order only with the antenna, free space calibration (horizontal), other calibrations on request
248504	BTP 6020A-0880 EMC Tripod with tube 880 mm and mounting head for antennas with 22 mm tube
248505	BTP 6020A-0680 EMC Tripod with tube 680 mm and mounting head for antennas with 22 mm tube
248523	BTP 6020A-1370 EMC Tripod with tube 1370 mm and mounting head for antennas with 22 mm tube